

HIGH STREAM 16

CHECK-IN

Design: Raif Keferstein

OLIGO Lichttechnik GmbH

Tannenweg 1

DE - 53757 Sankt Augustin

Germany

www.oligo.de

info@oligo.de









Art.-Nr. / Item-No.

30-968-10-XX

30-968-11-XX

30-968-12-XX

	max.250V	max. 50W	GU 10	QPAR 51
(D)	Spannung	Belastung	Fassung	Lampe
(GB)	Voltage	Loading	Fitting	Bulb
(NL)	Spanning	Belasting	Fitting	Verlichtingsmiddel
(F)	Tension	Charge	Douille	Ampoule
(I)	Tensione	Carico	Portalamпада	Sorgente luminosa
(ES)	Tensión	Carga	Portaámparas	Lámpara
(P)	Tensão	Carga	Casquilho	Lâmpada
(DK)	Spænding	Belastning	Fatning	Pære
(S)	Spänning	Belastning	Fattning	Ljuskälla
(N)	Spänning	Fatning	Belastning	Lampe
(FI)	Jännite	Kuormitus	Kanta	Lamppu
(TR)	Gerilim	Yük	Duy	Lamba
(PL)	Napięcie	Oprawka	Obciążenie	Lampa
(GR)	Τάση	Υποδοχή	Φορτίο	Λαμπτήρας
(RUS)	Напряжение	Нагрузка	Патрон	Лампочка
(JAE)	الجهد الكهربى	الدواة	الحمل	المصباح

	
	
	
LED READY	
	

A

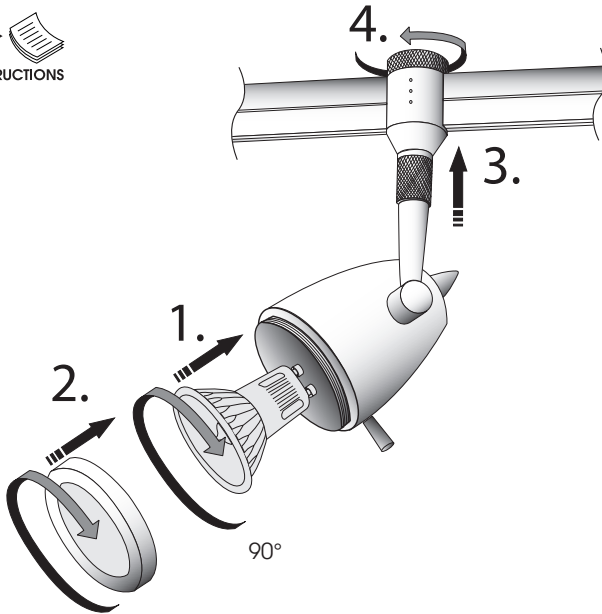

B

