





**TECHNICAL DATA**

220-240V<sub>AC</sub> 50Hz

**LED SOURCE:**

15,3 W

**SIZE cm:**

±102x45cm Hmax ±233cm



**F** This luminaire contains a light source with the energy class F.

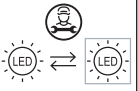
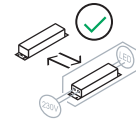

- **LEGGERE LE ISTRUZIONI GENERICHE PER L'INSTALLAZIONE DI TUTTI GLI APPARECCHI D'ILLUMINAZIONE.**
- **READ GENERAL INSTRUCTIONS FOR INSTALLING ALL LIGHTS.**
- **BITTE DIE ALLGEMEINE MONTAGEANLEITUNG FÜR ALLE LEUCHTEN LESEN.**
- **LIRE LES INSTRUCTIONS GÉNÉRALES POUR L'INSTALLATION DE TOUS LES APPAREILS D'ÉCLAIRAGE.**
- **LEER LAS INSTRUCCIONES GENERALES PARA LA INSTALACIÓN DE TODOS LOS APARATOS DE ILUMINACIÓN.**
- **ЧИТАЙТЕ ОБЩИЕ ИНСТРУКЦИИ ПО МОНТАЖУ.**

**PAG. I + II**

- Controllare che la superficie d'installazione e le viti che ad essa vengono fissate siano adeguate all'apparecchio e ne supportino il peso.
- Ensure the installation surface and the screws that are fastened onto it are suited to the fixture and withstand its weight.
- Sicherstellen, dass die Installationsoberfläche und die Schrauben, die an ihr befestigt werden, für das Gerät geeignet sind und sein Gewicht aushalten.
- Contrôler que la surface d'installation et les vis qui lui sont fixées soient appropriées à l'appareil et qu'elles sont en mesure d'en supporter le poids.
- Controle que la superficie de instalación y los tornillos fijados a ella sean adecuados para el aparato y soporten el peso.
- Проверить, что поверхность установки и крепежные болты соответствуют прибору и имеют подходящую грузоподъемность

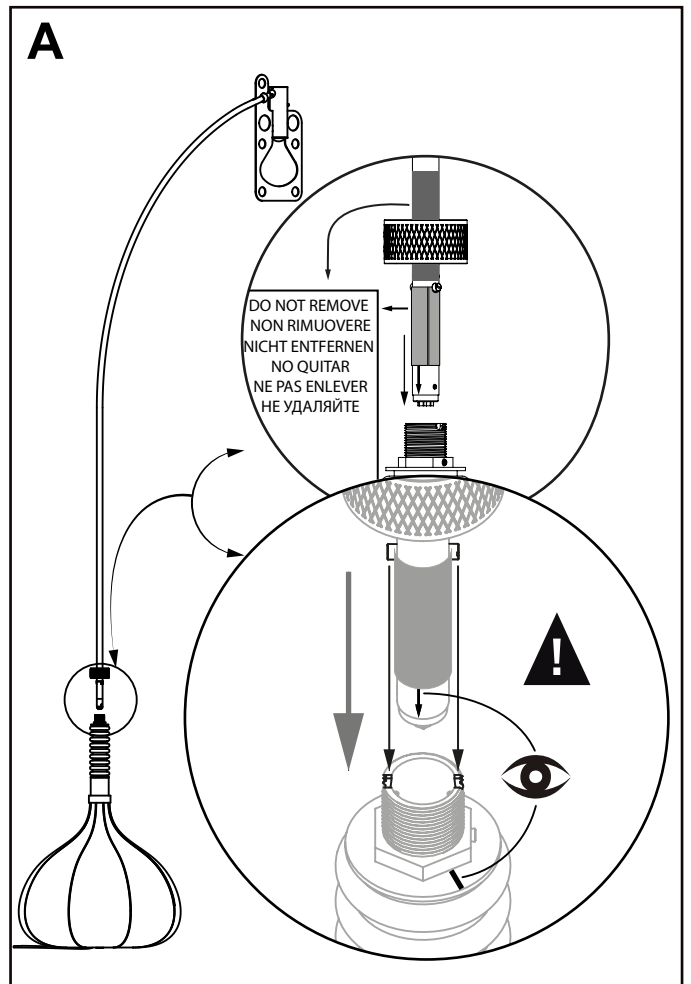
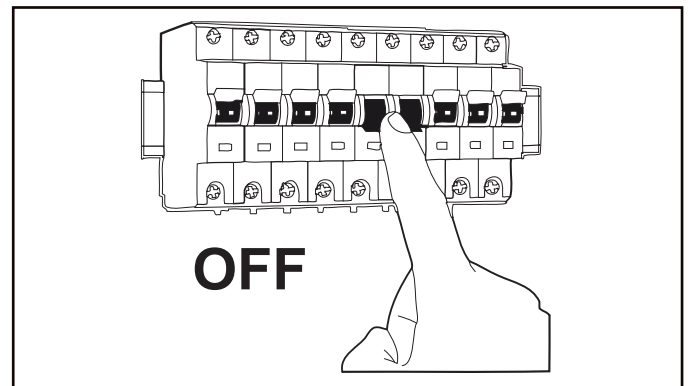
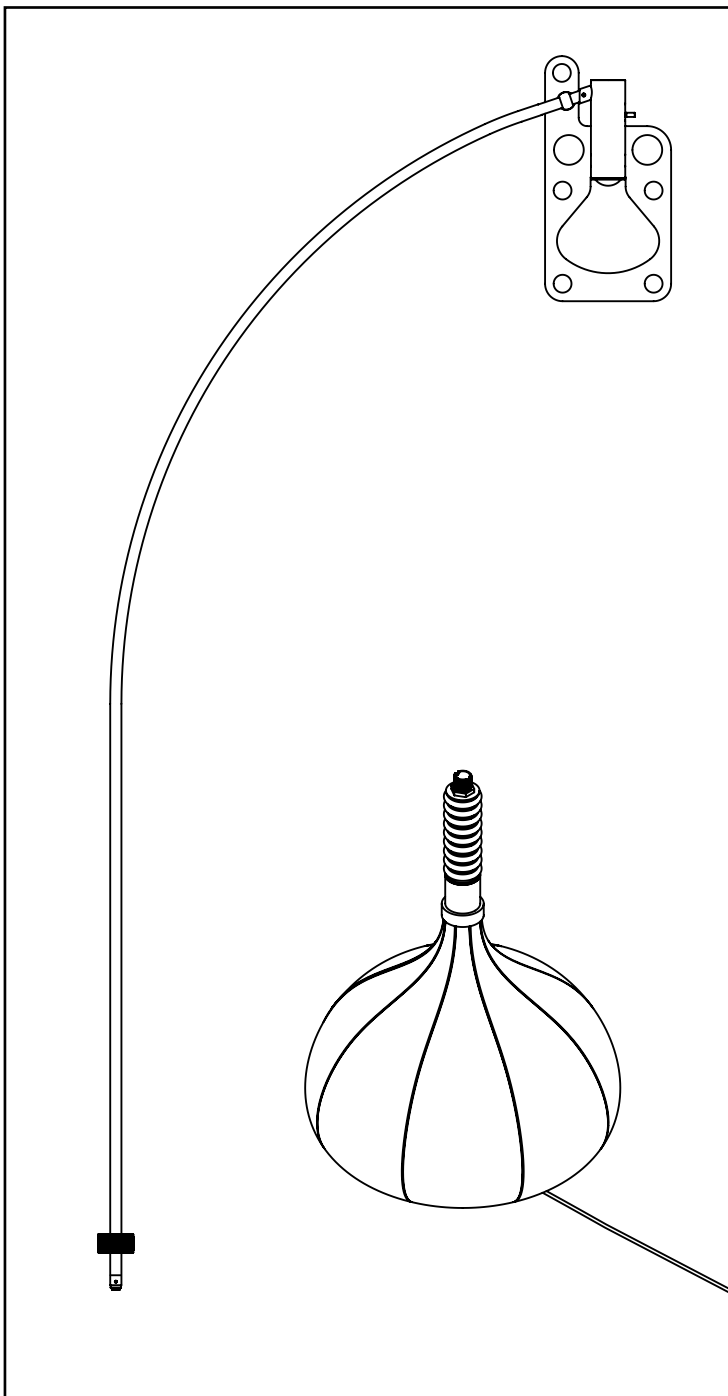

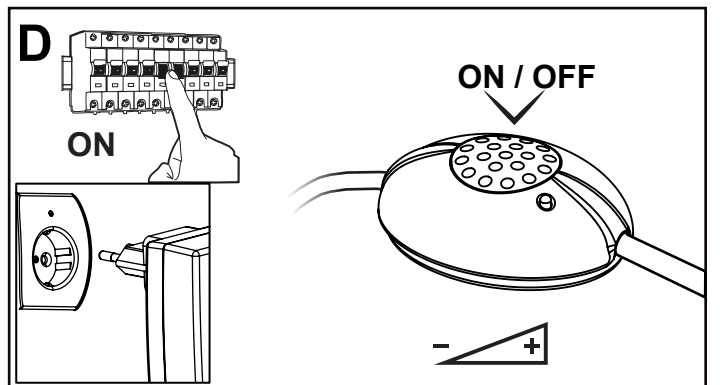
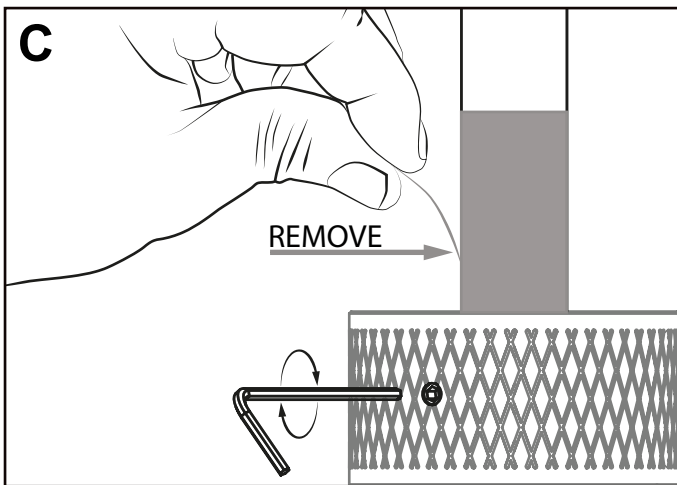
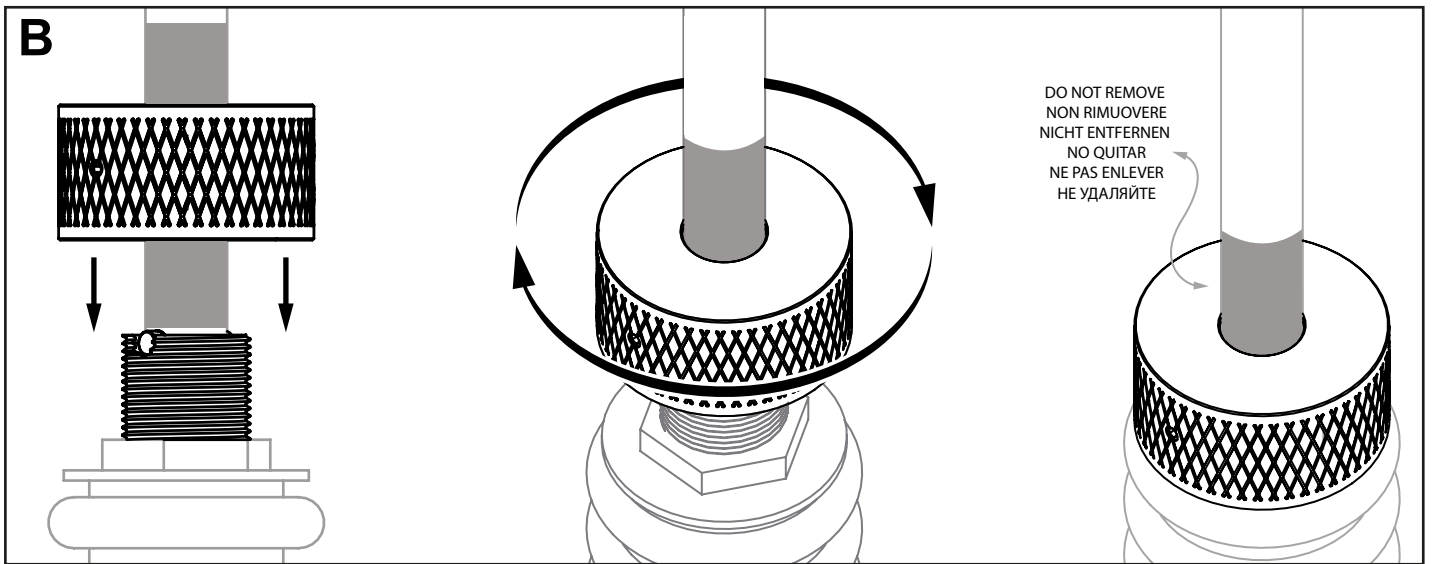

Prima di regolare la fonte luminosa aspettare 30 minuti o accertarsi che sia <30°C \ Wait 30 minutes or make sure it is <30°C / 85°F before adjusting the light source \ Avant de régler la source lumineuse attendez-vous 30 minutes ou assurez-vous que la température soit <30 °C

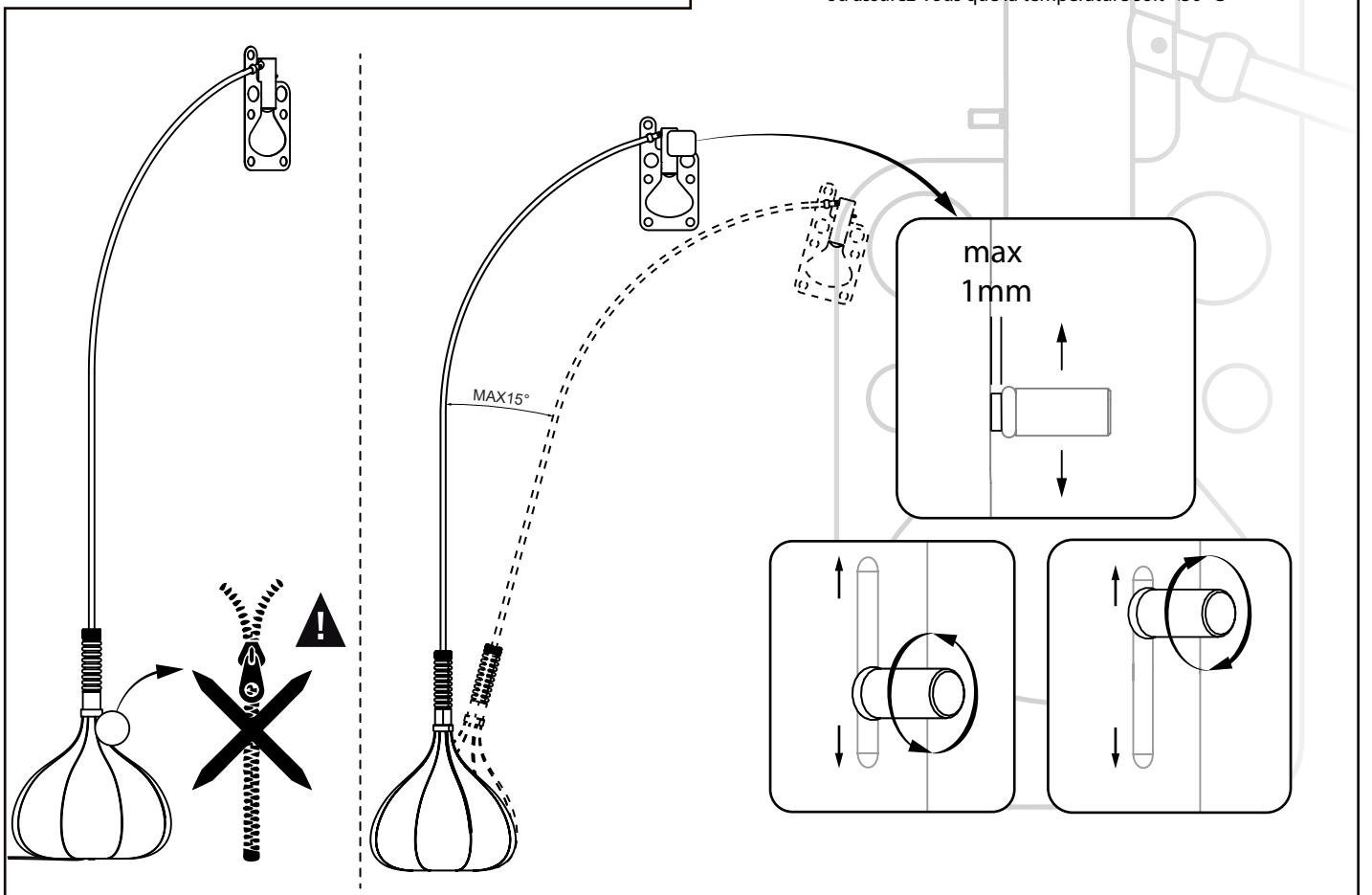

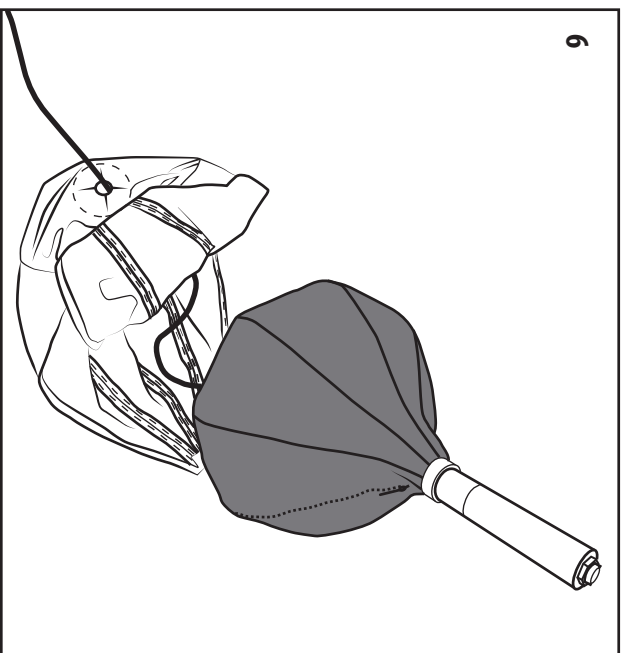
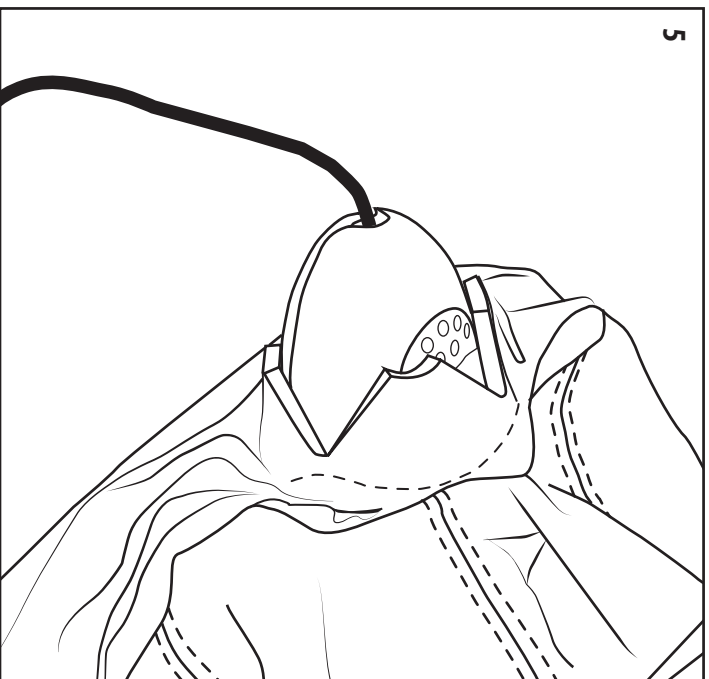
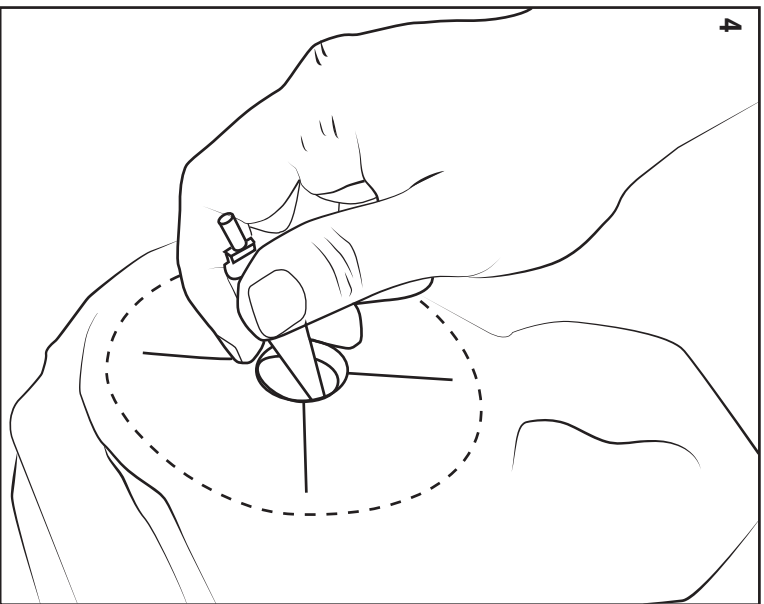
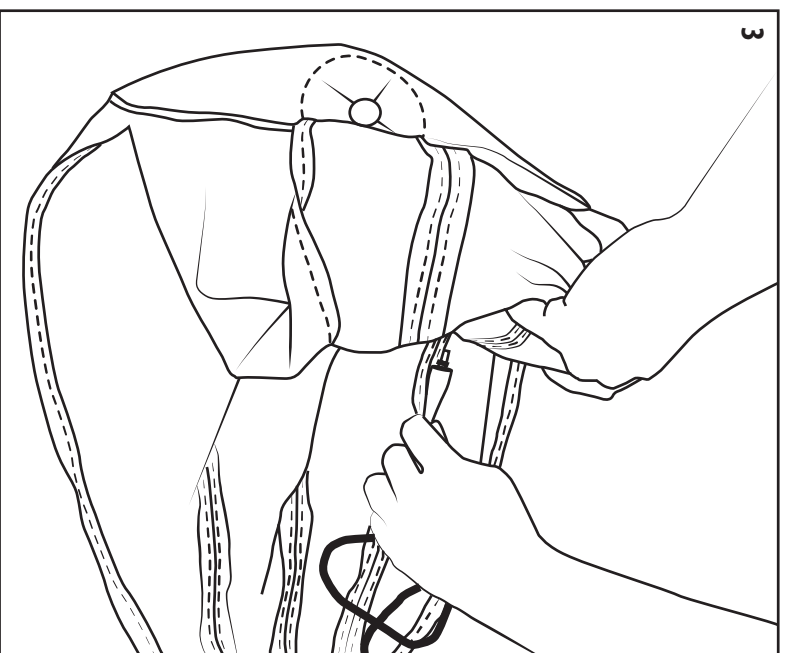
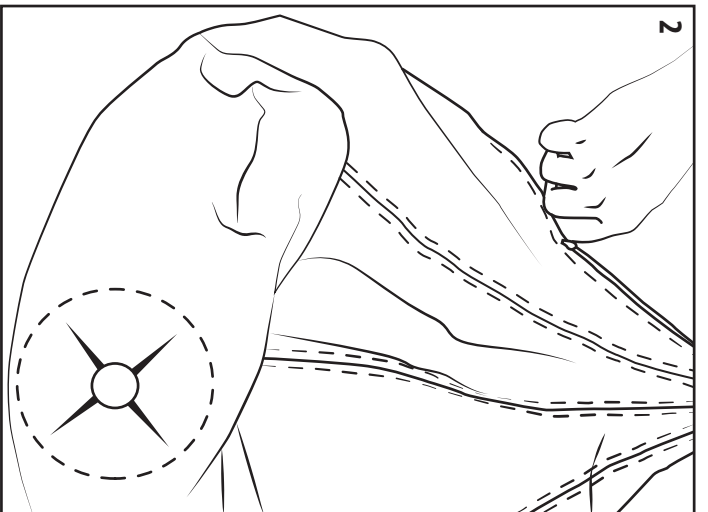
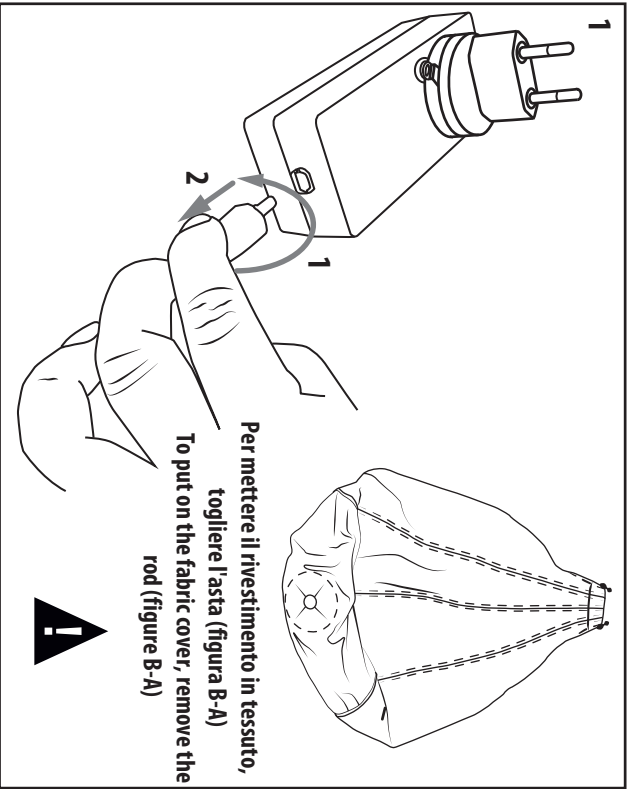

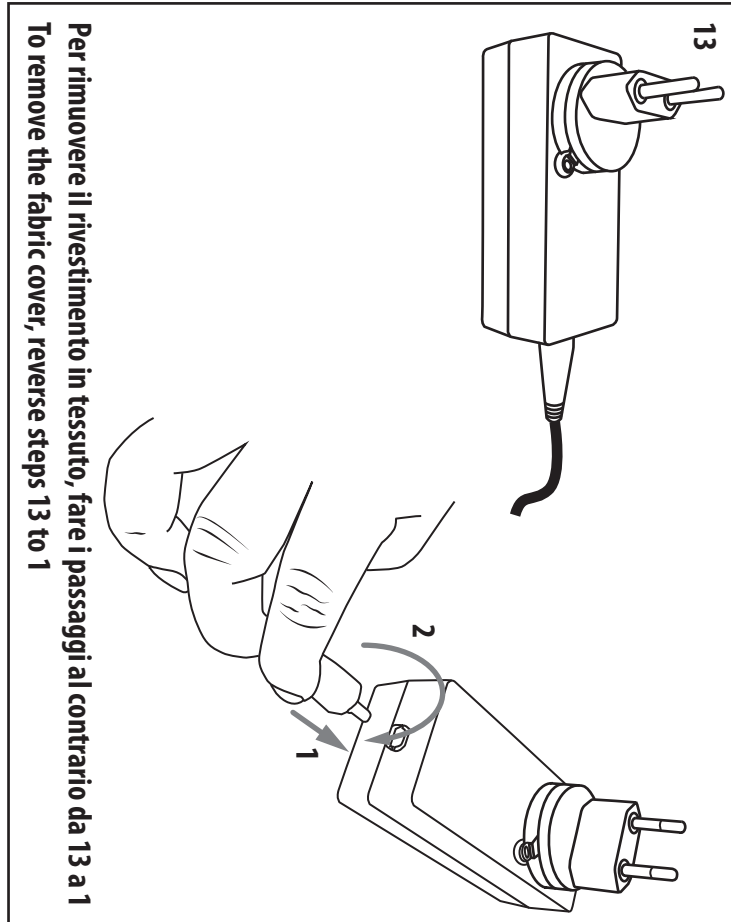
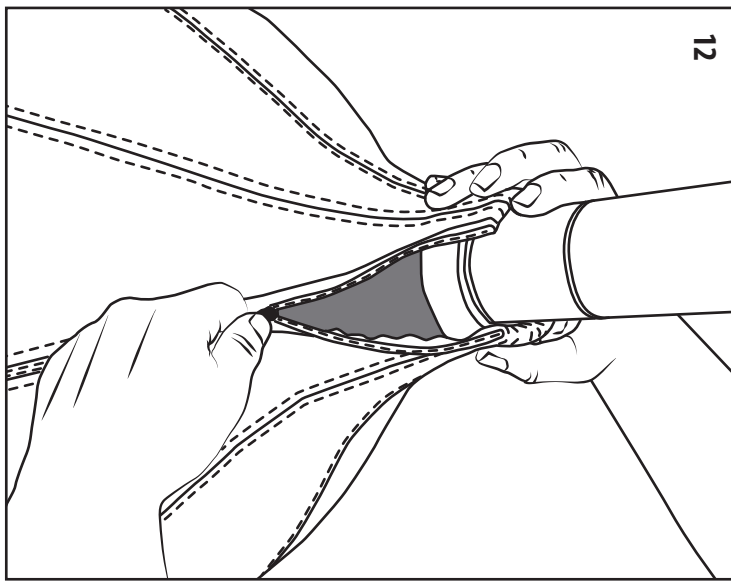
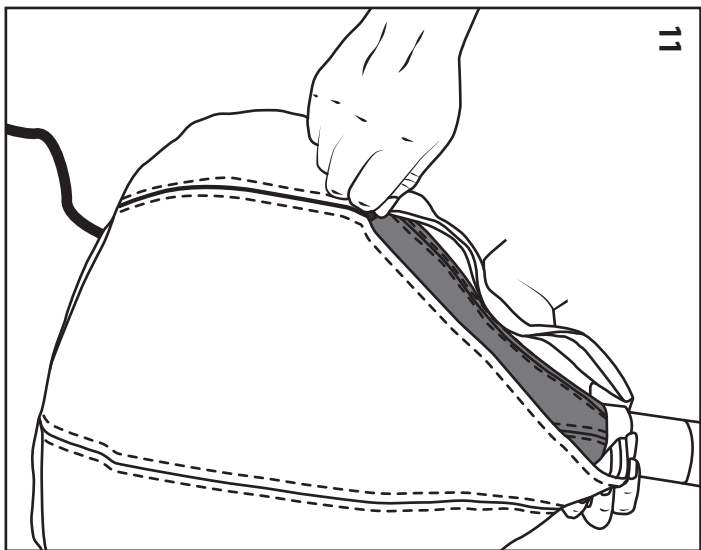
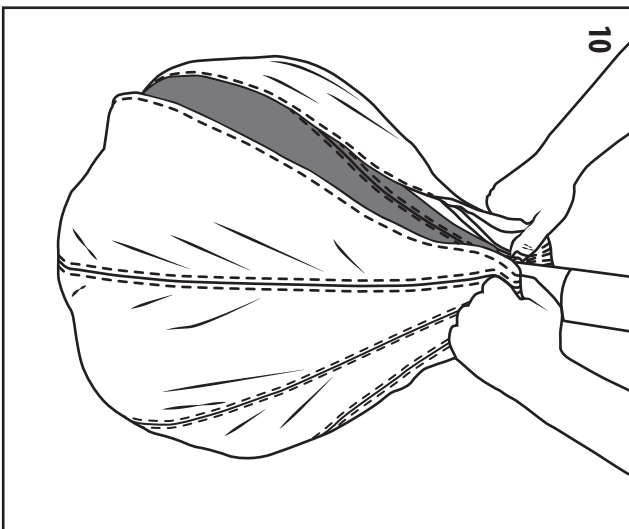
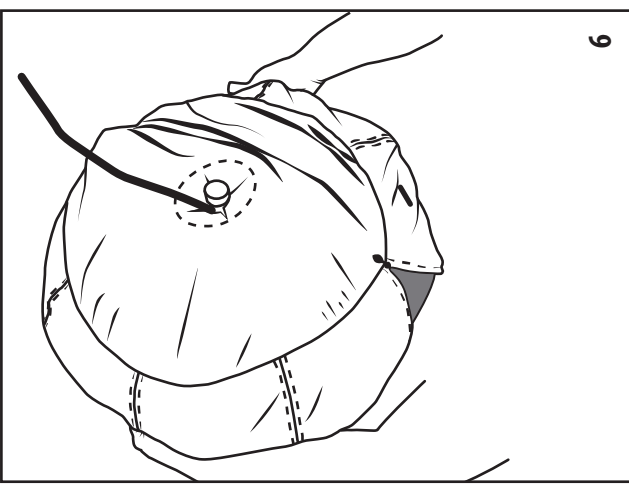
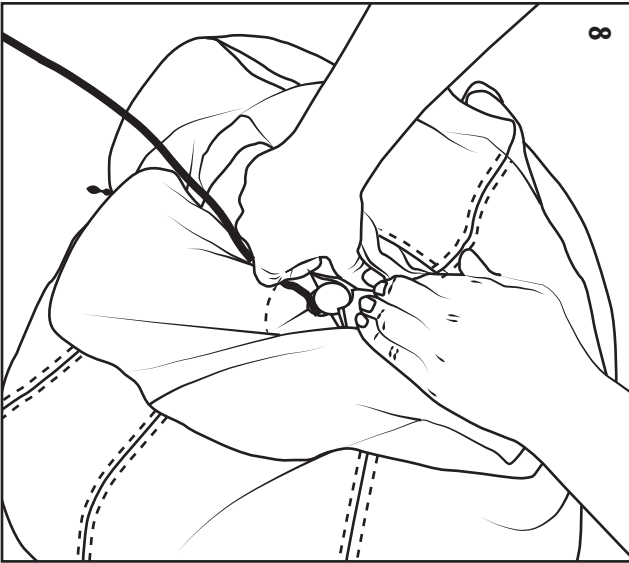
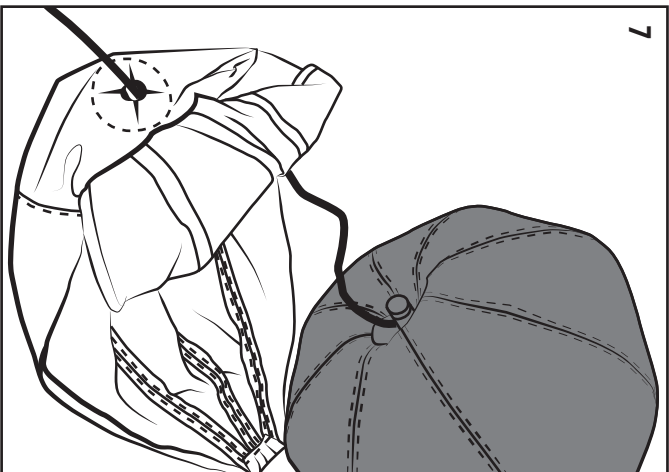

Per rimuovere il rivestimento in tessuto, fare i passaggi al contrario da 13 a 1  
To remove the fabric cover, reverse steps 13 to 1